

Performance optimization of mobile WiMAX networks for VoIP streams

L. Ortiz, V. Rangel, J. Gomez.
Department of Telecommunications
UNAM, Mexico City
{lortiz, victor, javierg}@fi-b.unam.mx

R. Santos
School of Telematics
UCOL, Colima, Mexico
aquinor@ucol.mx

M. Lopez-Guerrero
Department of Electrical Engineering
UAM-I, 09340 - Mexico City
milo@xanum.uam.mx

Abstract— Supporting as many VoIP (Voice over Internet Protocol) users as possible in a BWA (Broadband Wireless Access) network, using limited radio resources is a very important issue that could lead the IEEE 802.16e protocol to greater acceptance all over the world. However, VoIP service performance is affected by several characteristics defined in the BWA protocol, such as signaling overhead of control or MAP messages, ranging regions and wasted symbols, among others. In this paper we present a performance optimization to support the maximum number of VoIP calls, using codecs G.711 and G.723.1. Simulation results validate the performance optimization in terms of throughput and mean access delay for VoIP traffic.

Keywords- IEEE 802.16e, Mobile WiMAX, VoIP, G.711, G.723.1, Performance Optimization.

I. INTRODUCTION

The most promising solution for Broadband Wireless Access (BWA) networks is the IEEE 802.16e-2005 standard [1]. It supports mobility speeds of up to 120 km/h with an asymmetrical link structure and allows Subscriber Stations (SSs) to have a handheld form factor well suited for PDAs (Personal Digital Assistants), phones and laptops. In addition, a great deal of attention has been focused on VoIP because it is expected to be widely supported by mobile wireless networks. VoIP is a very important service because mobile users can make use of cheap voice services as compared with current mobile systems. Therefore, supporting as many VoIP users as possible in a BWA network, using limited radio resources, is a very important characteristic that could lead the IEEE 802.16e protocol to greater acceptance all over the world. However, VoIP performance is affected by several characteristics defined in the IEEE 802.16e standard, such as signaling overhead (MAP messages), ranging regions, contention, and wasted symbols due to “*rectangulation*” and “*quantization*” [1], among others.

Rectangulation is the process of allocating bandwidth resources in the downlink (DL) channel on a square or rectangular region of the frame structure. *Quantization* is the process of allocating these resources using the minimum allocation unit, denominated “*quantum map*”. Considering Partial Usage of Sub-Channels (PUSC), a *quantum map* or a slot in the DL channel is one subchannel times two OFDMA (Orthogonal Frequency Division Multiple Access) symbols. A *quantum map* in the uplink (UL) channel is one subchannel times three OFDMA symbols. These settings seriously affect

VoIP service performance because a VoIP packet allocation generally does not fit well in the DL and UL reservation space and usually multiple *quantum maps* are required.

Signaling overhead of MAP messages also affects VoIP services, because such overhead increases when the Base Station (BS) schedules small-sized VoIP packets. Some studies have evaluated VoIP performance taking into consideration mapping overhead [2], [3]. However, in these studies neither wasted resources in the DL channel due to *quantization* and *rectangulation* were considered nor ranging and contention signaling on the UL channel were taken into account.

A previous work presented an analytical model to evaluate VoIP performance [4]. This study takes into account the *quantization* and ranging regions in the DL and UL channels, respectively. However, wasted symbols due to *rectangulation* were not considered. The performance of some VoIP codecs has been evaluated in [5] and [6]. In [6] wasted symbols were considered, however they were considered as a result of variations of VoIP inter-arrival times and packet sizes. Moreover, in [5] and [6], the mapping overhead was not considered and the performance optimization of VoIP codecs based on OFDMA symbols for UL and DL channels was not addressed.

In this paper, we present a performance optimization of mobile WiMAX network parameters to support the maximum number of VoIP users. We make use of codecs G.711 and G.723.1 and the OPNET Modeler v.16. simulation package. The simulation model considers the issues that affect VoIP performance, such as wasted symbols due to *rectangulation* and *quantization*, signaling overhead of MAP messages, ranging and contention regions in the UL channel. In addition, a balanced amount of OFDMA symbols for each channel (UL and DL) is used in order to compensate for signaling overhead of MAP messages in the DL channel. Several modulations, codifications and encapsulations (with and without Header Suppression - HS [7]) are taken into account to evaluate the performance of G.711 and G.723.1 VoIP codecs under the IEEE 802.16e protocol.

The remainder of this paper is organized as follows. In Section II we present a brief description of the IEEE 802.16e protocol. In Section III and Section IV we derive theoretical and simulation models for VoIP traffic, respectively. Section V presents the performance optimization of mobile WiMAX

network parameters for VoIP traffic. Finally, in Section VI we present our conclusions.

II. IEEE 802.16E PROTOCOL DESCRIPTION

The IEEE 802.16e standard uses a Medium Access Control (MAC) protocol that makes use of both Frequency Division Duplex (FDD) and Time Division Duplex (TDD). A DL channel allows transmissions from a Base Station (BS) to SSs, with PMP (Point to Multi Point) wireless access using FDD or a time signaling frame for TDD.

Multiple SSs share one slotted UL channel via TDD on demand for voice, data, and multimedia traffic. Upon receiving a bandwidth request, the BS handles bandwidth allocation by assigning UL grants based on requests from SSs. A typical signaling frame for TDD includes a DL subframe and a UL subframe. In turn, the DL subframe includes a Preamble, Frame Control Header (FCH), and a number of data bursts for SSs as depicted in Fig. 1. The Preamble is used for synchronization and equalization, and contains a predefined sequence of well-known symbols at the receiver. The FCH specifies the burst profile and length of at least one DL burst immediately following the FCH. The DL-MAP and UL-MAP are MAC management messages that include Information Elements (IEs) in order to define network access and the burst start time. These messages are broadcast by the BS following the transmission of the FCH.

Upon entering the network, each SS has to go through the Initialization and Registration setup process as defined in the IEEE 802.16e standard. Once this setup is completed, a SS can create one or more connections over which its data is transmitted to and from the BS. SSs request transmission opportunities using the UL subframe. The BS collects these requests and determines the number of OFDMA symbols (grant size) that each SS will be allowed to transmit or receive in the UL or DL subframe, respectively. This information is broadcast in the DL channel by the BS in each DL-MAP and UL-MAP. The UL-MAP message contains the IEs which describe the use of the UL subframe, such as maintenance, contention and reservation access. After receiving a UL-MAP, a SS will transmit data in the predefined reserved OFDMA symbols (UL-burst) indicated in the IEs. The DL-MAP message contains the IEs which describe the reserved zone (DL-burst) where the SS will receive its requested information.

These OFDMA symbols are transmission opportunities assigned by the BS using a Quality of Service (QoS) class, such as UGS (Unsolicited Grant Service) for CBR (Constant Bit Rate) traffic, rTPS (real-time Polling Service) for VBR (Variable Bit Rate) such as video applications, nrtTPS (non real-time Polling Service) for non real-time bursty traffic, and BE (Best Effort) for Internet traffic such as email and all other non real-time traffic.

III. THEORETICAL ANALYSIS

In this section we present a theoretical analysis for the IEEE 802.16e MAC protocol when VoIP traffic (G.711 and G.723.1) is transmitted using a 20 MHz channel. The theoretical analysis can also be used to study other VoIP codecs (such as G.726,

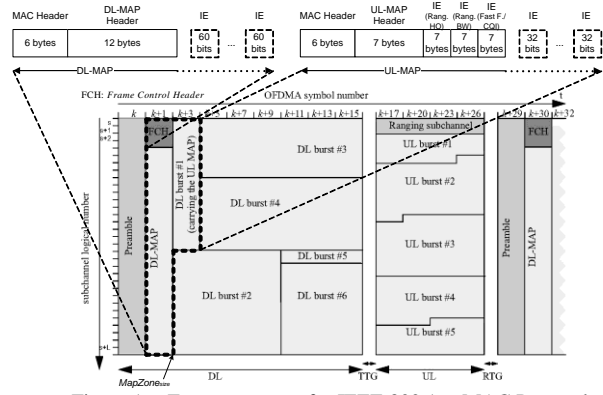

Figure 1. Frame structure for IEEE 802.16e MAC Protocol.

G.728, and G.729). We consider CBR traffic to load the network with short VoIP packets using UGS service class.

From Fig. 1 we can see that a DL subframe is comprised of a Preamble, a FCH, a DL-MAP message, a UL-MAP message and DL bursts. According to the standard 0, the Preamble and the FCH information are of constant size, but the DL-MAP and UL-MAP are of variable size.

Here the DL bursts are also constant since they are used to transport fixed-size VoIP frames. Therefore, in order to know the number of SSs supported in the DL direction ($VoIPstreams_{DL}$), we first need to compute the available number of OFDMA symbols at the PHY layer (Avl_{smbDL}) as

$$Avl_{smbDL} = \left\lfloor \frac{OFDMA_{smbDL} - Preamble_{smbDL}}{Q_{smbDL}} \right\rfloor * Q_{smbDL} * Data_{sbcDL} \quad (1)$$

where $OFDMA_{smbDL}$ is the number of OFDMA symbols per subframe. $Preamble_{smbDL}$ is the number of OFDMA symbols used for the Preamble. Q_{smbDL} is the number of OFDMA symbols that comprises a *quantum map* (also termed as the minimum reservation unit) in the DL subframe. Due to the fact that data regions have to be allocated on rectangular shapes in the DL channel according to [1], we rounded down Avl_{smbDL} to multiples of *quantum maps*. $Data_{sbcDL}$ is the number of subcarriers used for data transmission in the DL subframe. For the performance analysis we considered the default values according to [1], see Table I.

TABLE I. MAC AND PHY LAYER PARAMETERS FOR A 20 MHz CHANNEL.

Parameter	Description	Default value	
$Frame_d$	Frame Duration.	5ms	
FFB_{smb}	Symbols for Fast Feedback/CQI	6	
FFB_{sbc}	Sub-Channels for Fast Feedback/CQI	1	
$OFDMA_{smb}$	OFDMA Symbols (see Table II)	0[1-4]	
Rng_{smbBW}	Symbols for Ranging and BW request	1	
Rng_{smbHO}	Symbols for Ranging Handoff	2	
Rng_{sbcBW}	Sub-Channels for Ranging and BW Req	6	
Rng_{sbcHO}	Sub-Channels for Ranging Handoff	6	
		Subframe	
		UL	DL
$Data_{sbc}$	Data Sub-Carriers.	1120	1440
Q_{smb}	Quantum Symbol Size.	3	2
$SbCr_{sbc}$	Sub-Carriers per Sub-Channel.	16	24

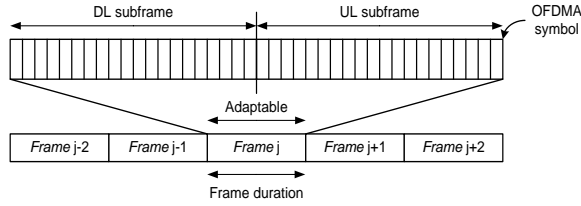

Figure 2. Variable number of OFDMA symbols for DL and UL frames.

TABLE II. OFDMA PARAMETER CONFIGURATIONS FOR UL AND DL SUBFRAMES.

Configuration	OFDMA _{smb}	
	UL	DL
00	9	38
01	12	35
02	15	32
03	18	29
04	21	26
05	24	23

In addition, $OFDMA_{smbDL}$ takes on values in the range of [2, 42], as defined in [1] for a 5ms frame duration ($Frame_d$). Thus, DL and UL subframes can have different configurations (θ) as shown in Fig. 2 and Table II.

Once fixed overhead has been deducted from Avl_{smbDL} (such as the *Preamble*), the number of SSSs supported in the DL direction is computed as follows,

$$VoIPstreams_{DL} = \left\lfloor \frac{CIntArv_{time}}{Frame_d} \left[\frac{Avl_{smbDL} - MapZone_{size} - Wstsm_{(N)}}{SSVoIP} \right] \right\rfloor, \quad (2)$$

here, we subtracted the variable overhead from Avl_{smbDL} ($MapZone_{size}$ and $Wstsm_{(N)}$). $MapZone_{size}$ is the number of OFDMA symbols used by the overhead as it is shown in Fig. 1 (upper section). This amount is variable and increases proportionally to the number of accepted SSSs in the network. This overhead is comprised of the fixed overhead of the Frame Control Header (FCH_{size}), the variable overhead formed by the DL MAP (Map_{sizeDL}), and the UL MAP (Map_{sizeUL}), as show in the following equation,

$$MapZone_{size} = FCH_{size} + Map_{sizeDL} + Map_{sizeUL}. \quad (3)$$

$Wstsm_{(N)}$ in (2) is the number or wasted symbols due to *rectangulation* and *quantization*, which also increases proportionally according to the number of accepted SSSs. It is computed as,

$$Wstsm_{(N)} = \sum_{n=1}^N Goffset_n, \quad (4)$$

where $Goffset_n$ is the n_{th} grant offset needed by the n_{th} data allocation. $CIntArv_{time}$ is the codec inter-arrival time, which was set to 10ms and 30ms for codecs G.711 and G.723.1, respectively. $SSVoIP$ is the VoIP frame size (in symbols) measured at the physical layer, considering the overhead

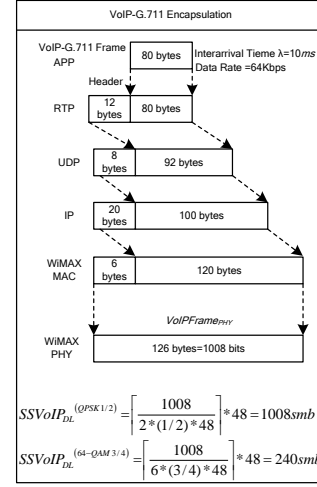

Figure 3. VoIP encapsulation for G.711 with QPSK1/2 and 64-QAM3/4.

TABLE III. NUMBER OF PHYSICAL SYMBOLS FOR $SSVoIP$ WITHOUT AND WITH HEADER SUPPRESSION (HS).

Codec	-HS		+HS	
	QPSK1/2	64-QAM3/4	QPSK1/2	64-QAM3/4
G.711	1008	240	816	192
G.723	528	144	336	96

produced by the protocol stack RTP/UDP/IP and WiMAX MAC. An example of the protocol encapsulation is shown in Fig. 3 for codec G711. Two modulations were used, QPSK1/2

(2 bits per symbol, codification=1/2) and 64-QAM3/4 (6 bits per symbol, codification=3/4). Here the constant 48 means the *quantum map* size (in symbols), where $quantum\ map = Qsmb * SbcR_{sbch}$.

Thus, $SSVoIP$ can have different values depending on the modulation, codification, encapsulation type and codec used. For instance, codecs G.711 and G.723.1 produce a VoIP frame of 80 and 20 bytes at the application layer, respectively. At the PHY layer, the reservation must be of 1008 and 528 symbols for G.711 and G.723.1 considering QPSK1/2, respectively. However, when a 64-QAM 3/4 is used, the reservation at the PHY layer is reduced to 240 and 144 symbols, respectively, as show in Table III, which also includes the grant size when header suppression (HS) is used. We have considered that HS reduces the RTP, UDP and IP protocol header from 40 to 27 bytes, according to [1].

Similarly, we follow the same procedure to compute the number of SSSs supported in the UL direction ($VoIPstreams_{UL}$). We computed the available number of OFDMA symbols at the PHY layer in the UL subframe (Avl_{smbUL}) taking away the ranging regions defined in [1] (as is shown in Fig. 1),

$$Avl_{smbUL} = \left(\left[\frac{OFDMA_{smbUL}}{Qsmb_{UL}} \right] * Qsmb_{UL} * Data_{sberUL} \right) - Rng_{smbHO} * Rng_{sbchHO} * SbcR_{sbchUL} - Rng_{smbBW} * Rng_{sbchBW} * SbcR_{sbchUL} - FFB_{smb} * FFB_{sbch} * SbcR_{sbchUL}, \quad (5)$$

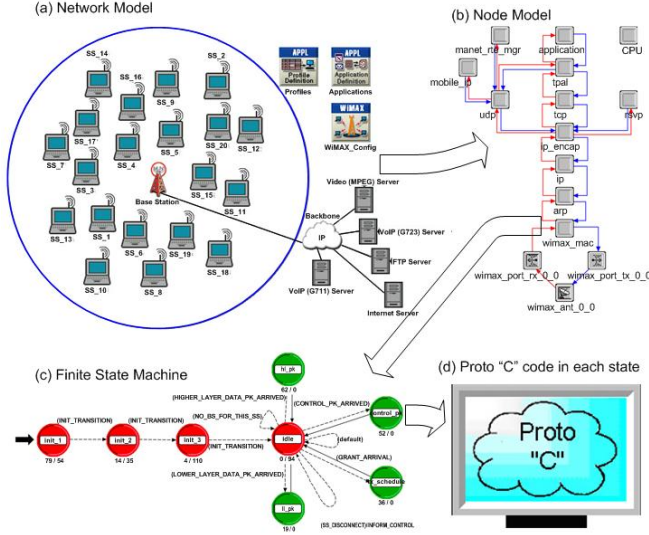

Figure 4. IEEE 802.16e simulation model.

where $OFDMA_{smbUL}$ is the number of OFDMA symbols in the UL subframe. We rounded down Avl_{smbUL} to multiples of *quantum maps*. Q_{smbUL} is the number of OFDMA symbols that comprises a *quantum map* in the UL subframe, and $Data_{sbcUL}$ is the number of data subcarriers used in the UL subframe. The ranging region is composed by the following parameters: Rng_{smbHO} , Rng_{sbcHO} , Rng_{smbBW} , Rng_{sbcBW} , FFB_{smb} , and FFB_{sbc} , defined in Table I. Thus, the number of supported SSs in the UL direction is computed as,

$$VoIPstreams_{UL} = \left\lfloor \frac{CIntArv_{time}}{Frame_d} \right\rfloor \left\lfloor \frac{Avl_{smbUL}}{SSVoIP} \right\rfloor \quad (6)$$

Finally, the maximum number of VoIP streams supported in an IEEE 802.16e network is given by,

$$MaxVoIPstreams = \min(VoIPstreams_{DL}, VoIPstreams_{UL}) \quad (7)$$

This means that we need to guarantee one VoIP stream in the UL direction and one VoIP stream in the DL direction in order to support a VoIP Call.

IV. SIMULATION MODEL

In order to validate the theoretical analysis, we implemented a WiMAX Mobile simulation model based on the OPNET MODELER package v.16. A hierarchical design was used and it is shown in Fig. 4. At the top level of the IEEE 802.16e network model are the network components (i.e., the BS and the SSs) as it is shown in Fig. 4a. The next hierarchical level, illustrated Fig. 4b, defines the functionality of an SS in terms of components such as traffic sources, TCP/UDP, IP, MAC and PHY interfaces. The operation of each component is defined by a Finite State Machine (an example of which is shown in Fig. 4c). The actions of a component at a particular state are defined in Proto-C code (see Fig. 4d).

This approach allows modifications to be applied to the operation of the IEEE 802.16e MAC protocol and different optimizations and enhancements can be tested. We simulated

TABLE IV. OFDMA SYMBOL OPTIMIZATION FOR UL AND DL SUBFRAMES WITH DIFFERENT MODULATION AND CODING.

Scenery	-HS				+HS			
	QPSK1/2		64-QAM3/4		QPSK1/2		64-QAM3/4	
	UL	DL	UL	DL	UL	DL	UL	DL
G.711	18	29	18	29	21	26	15	32
G.723	21	26	15	32	18	29	12	35

two scenarios, one for G.711 codec and the other for G.723.1 codec. Each scenario uses a bandwidth channel of 20 MHz, $Data_{sbcDL}=1440$, $Data_{sbcUL}=1120$, $Frame_d=5ms$ and a repetition count of FCH and DL-MAP message equals to 4, which must be used in the worst case scenario in networks with high mobility and a high level of interference.

V. PERFORMANCE EVALUATION

In order to achieve the maximum number of VoIP streams, we optimized the number of OFDMA symbols for the UL and DL subframes ($OFDMA_{smbUL}$ and $OFDMA_{smbDL}$). The best system configuration for the simulated scenarios is shown in Table IV.

Figures 5 and 6 show the network performance in terms of system throughput and mean access delay, respectively. In Fig. 5 we can see the throughput for the UL direction. We also found the same throughput for the DL direction, thus Fig. 5 also applies for the DL channel. In Fig. 5a, the maximum number of quality phone calls ($VoIPstreams$) supported was of 38 using G.711 codec with QPSK1/2 and without HS (-HS). This is the result of having 38 outgoing VoIP streams in the UL subframe and 38 ingoing VoIP streams in the DL subframe. In the same scenario, but considering HS (+HS), we have an increase of 45% regarding the maximum number of $VoIPstreams$ which was 54. However, when 64-QAM3/4 was used, the maximum number of $VoIPstreams$ increased considerably to 144 and 170 for -HS and +HS, respectively.

In Fig. 5.b we show the results for G723.1 codec, which reduces the application data rate from 64 kbps to 5.3kbps, increasing considerably the maximum number of $VoIPstreams$. With G.723.1 codec with QPSK1/2, the maximum number of $VoIPstreams$ supported was of 228 without HS and 348 with HS, here the increase was of 53%. The best results were obtained with 64-QAM3/4, where we found that the maximum number of supported $VoIPstreams$ could be up to 600 -HS and 738 +HS phone calls. Fig. 6 shows the mean access delay of VoIP frames in the UL direction. For G.711 codec we can that the simulated mean access delays are between 8 and 14 ms, which are under the maximum 50ms end-to-end delay (ETE) delay allowed for VoIP calls with high quality. For G.723.1 codec, the simulated mean access delays are between 18 and 26ms, which also are still below the maximum ETE delay.

VI. CONCLUSIONS

Performance optimization presented in this paper indicates that VoIP streams, under different configurations, can be supported by the IEEE 802.16e protocol. There is, however, a performance issue that needs to be considered.

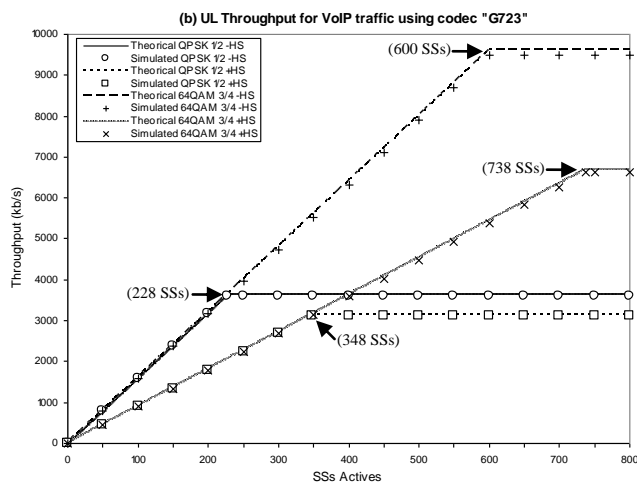
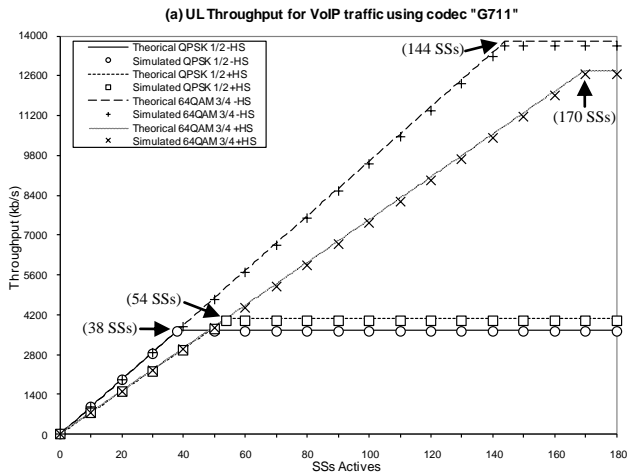

Figure 5. Maximum System Throughput of VoIP traffic in a 20 MHz Channel.

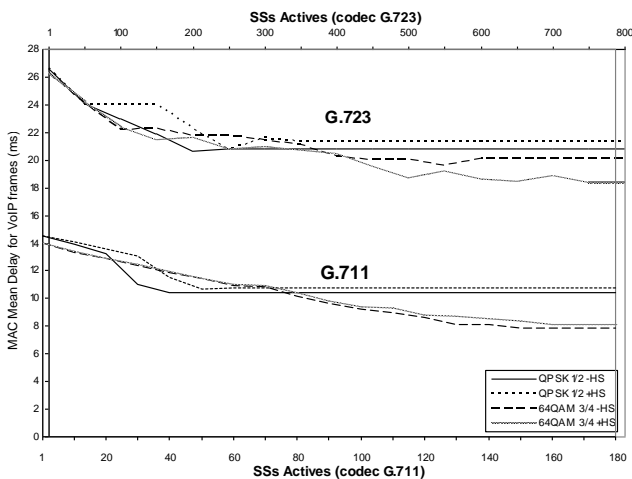

Figure 6. Mean Access Delay of VoIP traffic in a 20 MHz Channel.

The general trend from the results was that the system would comfortably support a number of active SSs transmitting one UL VoIP stream and one DL VoIP stream, where the maximum system throughput is obtained at the point when all available OFDMA symbols are scheduled. After that point, even a slight increase in the number of SSs results in system instability. Performance deterioration is not gradual and the packet access delay increases rapidly after this threshold if there is no admission control on the accepted traffic.

ACKNOWLEDGMENT

This work was supported by DGAPA, National Autonomous University of Mexico (UNAM) under Grant PAPIIT IN108910, IN 106609, PAPIME PE103807 and CONACyT 105279, 105117.

REFERENCES

- [1] IEEE 802.16e-2005, "IEEE Standard for Local and Metropolitan Area Networks - Part 16: Air Interface for Fixed BWA Systems," Amendment for PHY and MAC for Combined Fixed and Mobile Operation in Licensed Bands, Dec. 2005.
- [2] Jae Woo So, "A Downlink Performance Analysis of VoIP Services Over an IEEE 802.16e OFDMA System," IEEE Communications Letters, Feb. 2007.
- [3] Jaewoo So, "Performance Analysis of a Semi-Fixed Mapping Scheme for VoIP Services in Wireless OFDMA Systems," Fifth International Conference on Wireless Mobile Communications, Oct. 2009.
- [4] Jae-Woo So, "Performance Analysis of VoIP Services in the IEEE 802.16e OFDMA System With Inband Signaling," IEEE Transactions on Vehicular Technology, May 2008.
- [5] Kaarthick B., Yeshwenth V. J., Nagarajan N., Rajeev, "Investigating the performance of various vocoders for Fair scheduling algorithm in WiMAX," First Asian Himalayas International Conference, Nov. 2009.
- [6] Howon Lee, Hyu-Dae Kim, Dong-Ho Cho, "Extended-rtPS+ Considering Characteristics of VoIP Coders in Mobile WiMAX," IEEE 19th International Symposium on PIMRC, Dec. 2008.
- [7] ETSI ES 200 800 v.1.3.1. "Digital Video Broadcasting: Interaction Channel for Cable TV Distribution Systems (CATV)," Oct. 2001.