

PING)))™ Ultrasonic Distance Sensor (#28015)

The Parallax PING))) ultrasonic distance sensor provides precise, non-contact distance measurements from about 2 cm (0.8 inches) to 3 meters (3.3 yards). It is very easy to connect to microcontrollers such as the BASIC Stamp®, SX or Propeller chip, requiring only one I/O pin.

The PING))) sensor works by transmitting an ultrasonic (well above human hearing range) burst and providing an output pulse that corresponds to the time required for the burst echo to return to the sensor. By measuring the echo pulse width, the distance to target can easily be calculated.

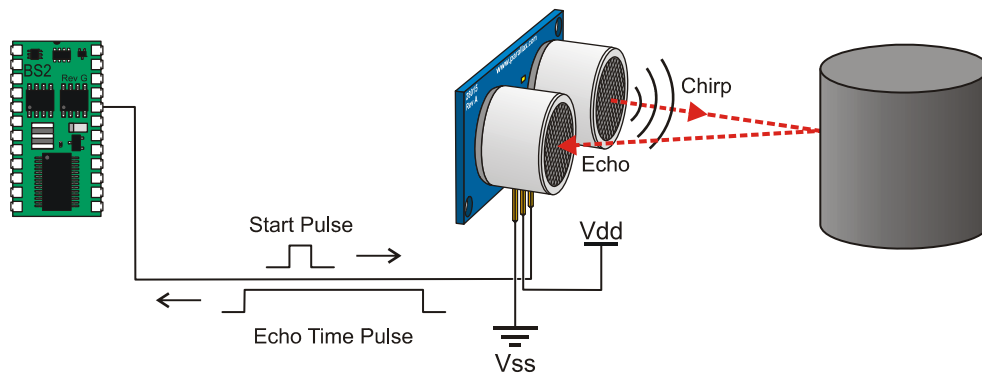

Features

- Range: 2 cm to 3 m (0.8 in to 3.3 yd)
- Burst indicator LED shows sensor activity
- Bidirectional TTL pulse interface on a single I/O pin can communicate with 5 V TTL or 3.3 V CMOS microcontrollers
- Input trigger: positive TTL pulse, 2 μ s min, 5 μ s typ.
- Echo pulse: positive TTL pulse, 115 μ s minimum to 18.5 ms maximum.
- RoHS Compliant

Key Specifications

- Supply voltage: +5 VDC
- Supply current: 30 mA typ; 35 mA max
- Communication: Positive TTL pulse
- Package: 3-pin SIP, 0.1" spacing (ground, power, signal)
- Operating temperature: 0 – 70° C.
- Size: 22 mm H x 46 mm W x 16 mm D (0.84 in x 1.8 in x 0.6 in)
- Weight: 9 g (0.32 oz)

Pin Definitions

GND	Ground (Vss)
5 V	5 VDC (Vdd)
SIG	Signal (I/O pin)

The PING))) sensor has a male 3-pin header used to supply ground, power (+5 VDC) and signal. The header may be plugged into a directly into solderless breadboard, or into a standard 3-wire extension cable (Parallax part #805-000012).

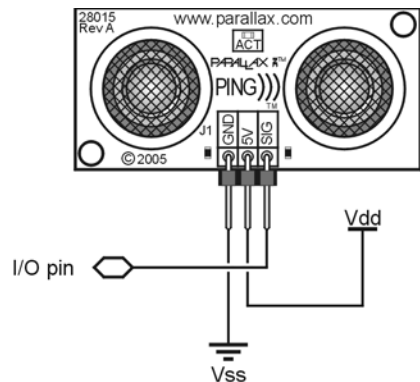

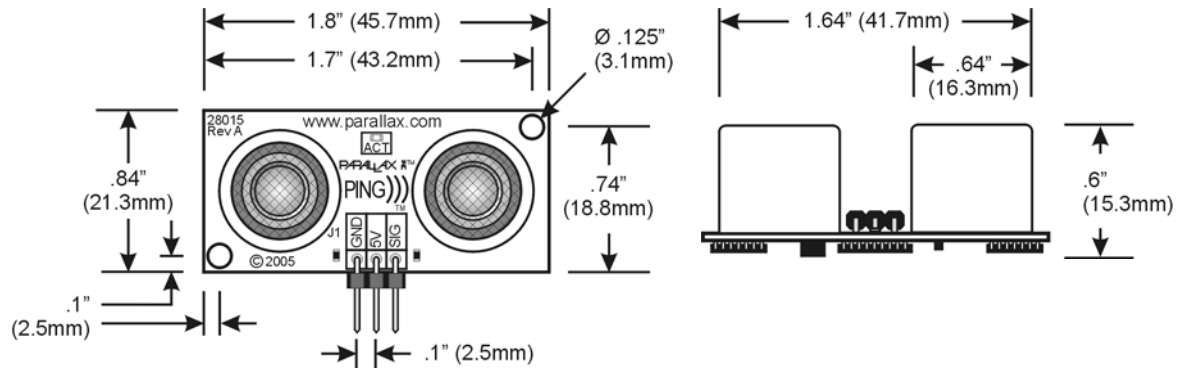

Dimensions

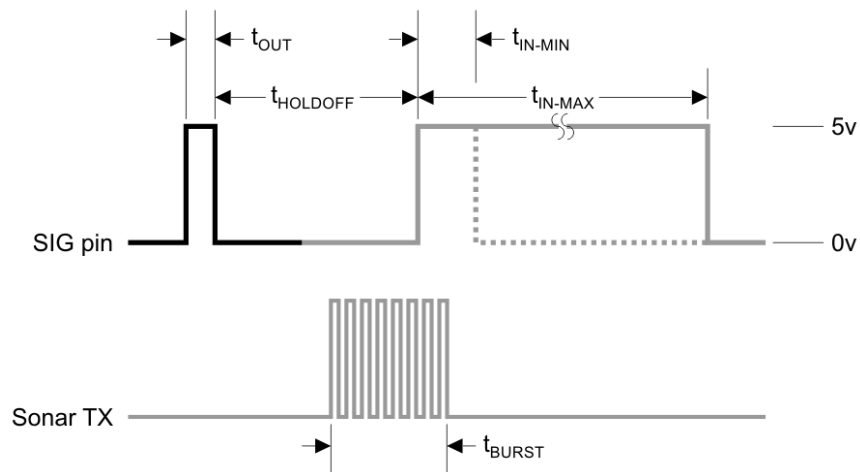

Communication Protocol

The PING))) sensor detects objects by emitting a short ultrasonic burst and then "listening" for the echo. Under control of a host microcontroller (trigger pulse), the sensor emits a short 40 kHz (ultrasonic) burst. This burst travels through the air, hits an object and then bounces back to the sensor. The PING))) sensor provides an output pulse to the host that will terminate when the echo is detected, hence the width of this pulse corresponds to the distance to the target.



	Host Device	Input Trigger Pulse	t_{OUT}	2 μ s (min), 5 μ s typical
	PING))) Sensor	Echo Holdoff	$t_{HOLDOFF}$	750 μ s
		Burst Frequency	t_{BURST}	200 μ s @ 40 kHz
		Echo Return Pulse Minimum	t_{IN-MIN}	115 μ s
		Echo Return Pulse Maximum	t_{IN-MAX}	18.5 ms
		Delay before next measurement		200 μ s

Practical Considerations for Use

Object Positioning

The PING))) sensor cannot accurately measure the distance to an object that: a) is more than 3 meters away, b) that has its reflective surface at a shallow angle so that sound will not be reflected back towards the sensor, or c) is too small to reflect enough sound back to the sensor. In addition, if your PING))) sensor is mounted low on your device, you may detect sound reflecting off of the floor.

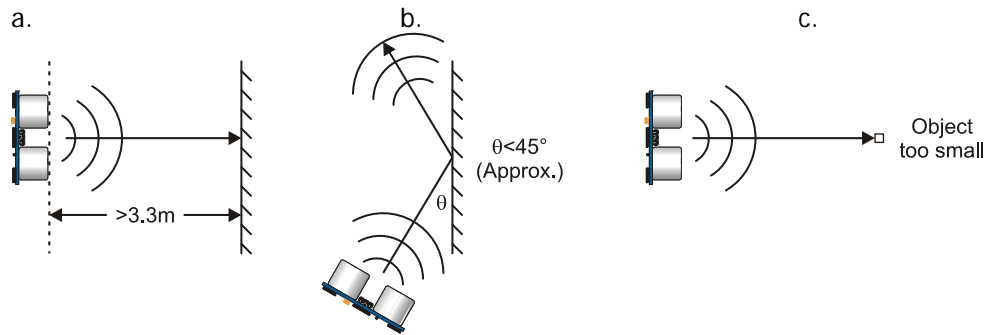

Target Object Material

In addition, objects that absorb sound or have a soft or irregular surface, such as a stuffed animal, may not reflect enough sound to be detected accurately. The PING))) sensor will detect the surface of water, however it is not rated for outdoor use or continual use in a wet environment. Condensation on its transducers may affect performance and lifespan of the device. See the "Water Level with PING)))" document on the 28015 product page at www.parallax.com for more information.

Air Temperature

Temperature has an effect on the speed of sound in air that is measurable by the PING))) sensor. If the temperature ($^{\circ}\text{C}$) is known, the formula is:

$$C_{\text{air}} = 331.5 + (0.6 \times T_c) \text{ m/s}$$

The percent error over the sensor's operating range of 0 to 70 $^{\circ}\text{C}$ is significant, in the magnitude of 11 to 12 percent. The use of conversion constants to account for air temperature may be incorporated into your program (as is the case in the example BS2 program given in the Example Programs section below). Percent error and conversion constant calculations are introduced in Chapter 2 of *Smart Sensors and Applications*, a Stamps in Class text available for download from the 28029 product page at www.parallax.com.

Test Data

The test data on the following pages is based on the PING))) sensor, tested in the Parallax lab, while connected to a BASIC Stamp microcontroller module. The test surface was a linoleum floor, so the sensor was elevated to minimize floor reflections in the data. All tests were conducted at room temperature, indoors, in a protected environment. The target was always centered at the same elevation as the PING))) sensor.

Test 1

Sensor Elevation: 40 in. (101.6 cm)
Target: 3.5 in. (8.9 cm) diameter cylinder, 4 ft. (121.9 cm) tall – vertical orientation

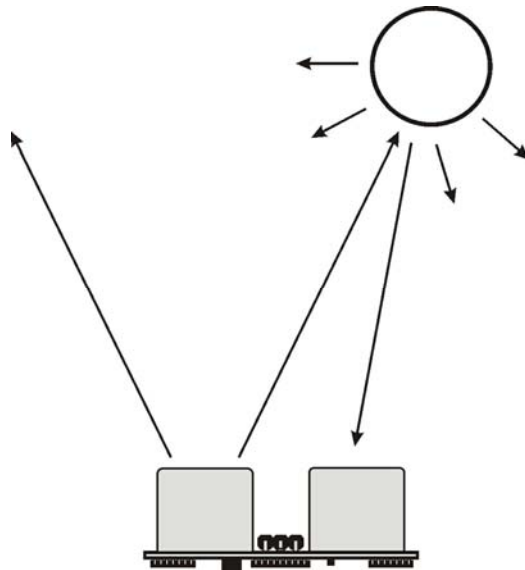
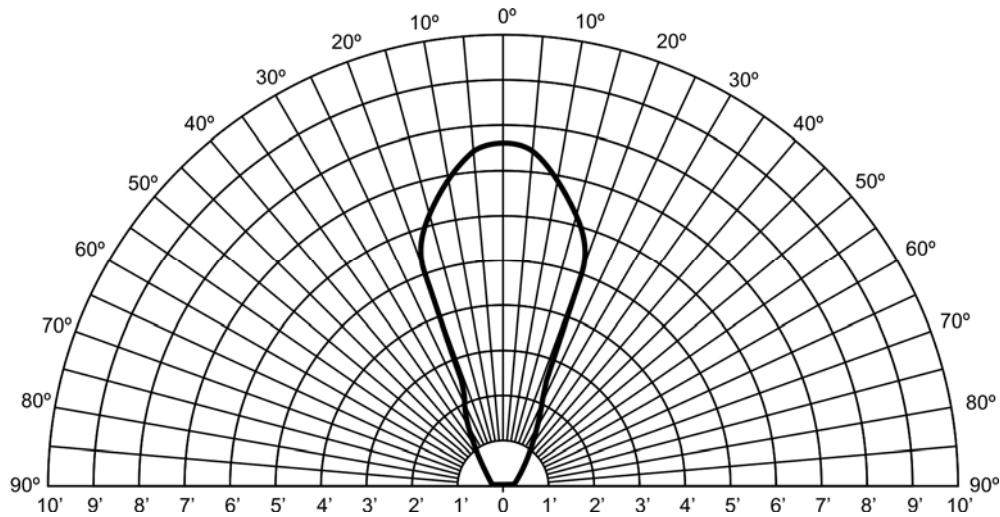

Test 2

Sensor Elevation: 40 in. (101.6 cm)
Target: 12 in. x 12 in. (30.5 cm x 30.5 cm) cardboard, mounted on 1 in. (2.5 cm) pole
Target positioned parallel to backplane of sensor

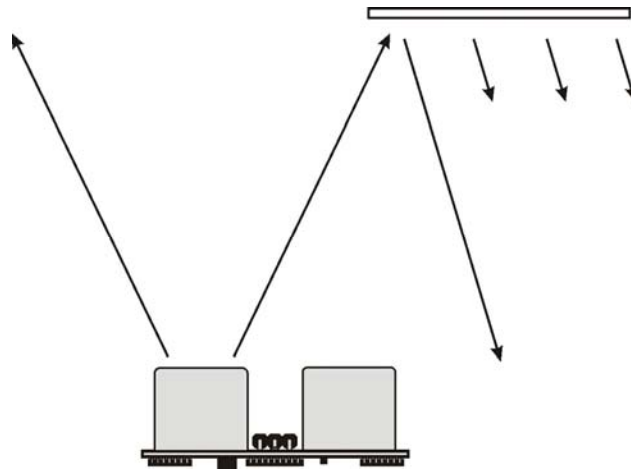
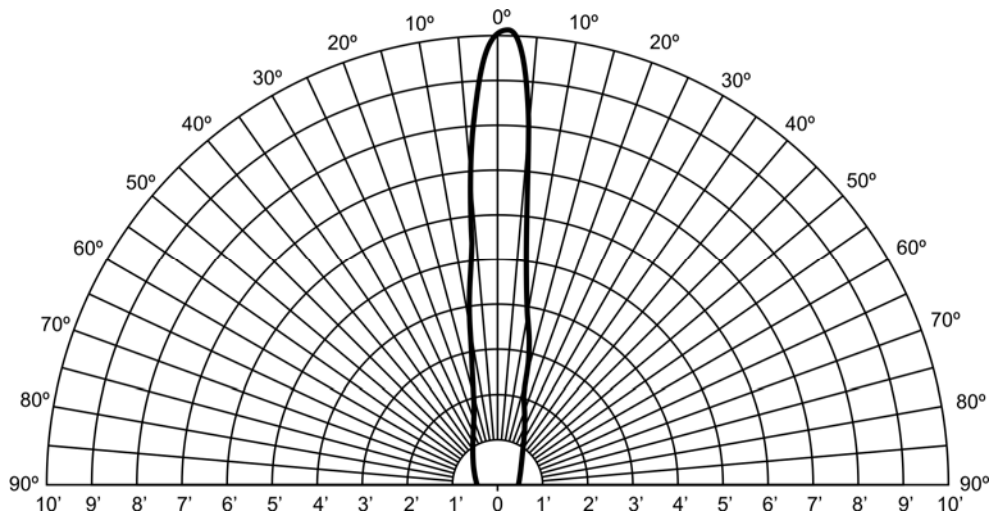

Example Programs and Applications

BASIC Stamp 2

This circuit allows you to quickly connect your PING))) sensor to a BASIC Stamp[®] 2 via the Board of Education[®] breadboard area. The PING))) module's GND pin connects to Vss, the 5 V pin connects to Vdd, and the SIG pin connects to I/O pin P15. This circuit will work with the example BASIC Stamp program listed below.

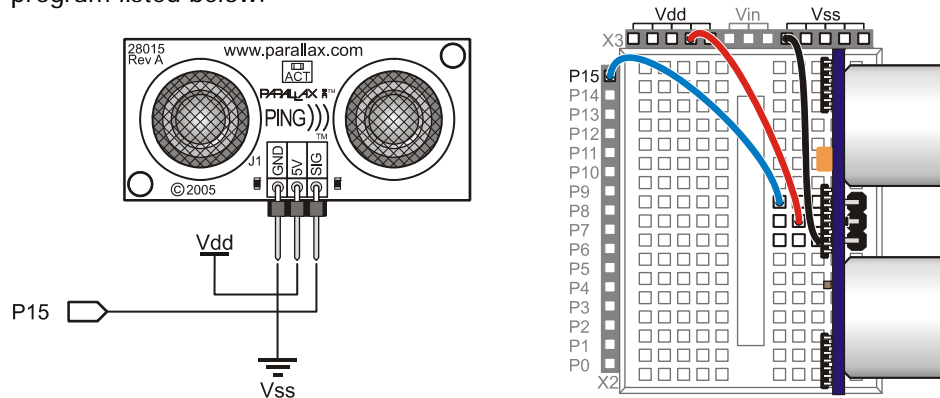

Extension Cable and Port Cautions for the Board of Education

If you are connecting your PING))) sensor to a Board of Education platform using an extension cable, follow these steps:

1. When plugging the cable onto the PING))) sensor, connect Black to GND, Red to 5 V, and White to SIG.
2. Check to see if your Board of Education servo ports have a jumper, as shown at right.
3. If your Board of Education servo ports have a jumper, set it to Vdd as shown. Then plug the cable into the port, matching the wire color to the labels next to the port.
4. If your Board of Education servo ports do not have a jumper, **do not use them with the PING))) sensor**. These ports only provide Vin, not Vdd, and this may damage your PING))) sensor. Go to the next step.
5. Connect the cable directly to the breadboard with a 3-pin header as shown above. Then, use jumper wires to connect Black to Vss, Red to Vdd, and White to I/O pin P15.

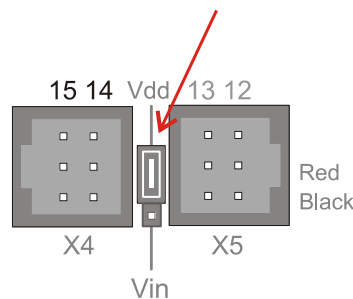

Board of Education Servo Port Jumper, Set to Vdd

Example Program: PingMeasureCmAndIn.bs2

This example BS2 program is an excerpt from Chapter 2 of the Stamps in Class text *Smart Sensors and Applications*. Additional PBASIC programs, one for the BS1 and another than runs on any model of BASIC Stamp 2 (BS2, BS2e, BS2sx, BS2p, BS2pe, BS2px) can be downloaded from the 28015 product page.

```
' Smart Sensors and Applications - PingMeasureCmAndIn.bs2
' Measure distance with Ping))) sensor and display in both in & cm

' {$STAMP BS2}
' {$PBASIC 2.5}

' Conversion constants for room temperature measurements.
CmConstant    CON    2260
InConstant    CON    890

cmDistance    VAR    Word
inDistance    VAR    Word
time          VAR    Word

DO

    PULSOUT 15, 5
    PULSIN 15, 1, time

    cmDistance = cmConstant ** time
    inDistance = inConstant ** time

    DEBUG HOME, DEC3 cmDistance, " cm"
    DEBUG CR, DEC3 inDistance, " in"

    PAUSE 100

LOOP
```

Propeller Microcontroller

```
{
*****
*      Ping))) Object V1.1      *
*      (C) 2006 Parallax, Inc.  *
* Author:  Chris Savage & Jeff Martin *
* Started: 05-08-2006          *
*****
```

Interface to Ping))) sensor and measure its ultrasonic travel time. Measurements can be in units of time or distance. Each method requires one parameter, Pin, that is the I/O pin that is connected to the Ping)))'s signal line.

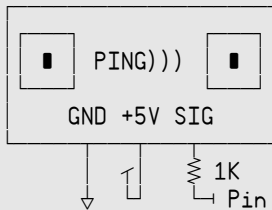

Connection To Propeller
Remember PING))) Requires
+5V Power Supply

```
-----REVISION HISTORY-----
v1.1 - Updated 03/20/2007 to change SIG resistor from 10K to 1K
}}
```

CON

```
TO_IN = 73_746      ' Inches
TO_CM = 29_034     ' Centimeters
```

PUB Ticks(Pin) : Microseconds | cnt1, cnt2

''Return Ping)))'s one-way ultrasonic travel time in microseconds

```
outa[Pin]~          ' Clear I/O Pin
dira[Pin]~~         ' Make Pin Output
outa[Pin]~~         ' Set I/O Pin
outa[Pin]~          ' Clear I/O Pin (> 2 µs pulse)
dira[Pin]~          ' Make I/O Pin Input
waitpne(0, |< Pin, 0) ' Wait For Pin To Go HIGH
cnt1 := cnt         ' Store Current Counter Value
waitpeq(0, |< Pin, 0) ' Wait For Pin To Go LOW
cnt2 := cnt         ' Store New Counter Value
Microseconds := (|(cnt1 - cnt2) / (clkfreq / 1_000_000)) >> 1 ' Return Time in µs
```

PUB Inches(Pin) : Distance

''Measure object distance in inches

```
Distance := Ticks(Pin) * 1_000 / TO_IN ' Distance In Inches
```

PUB Centimeters(Pin) : Distance

''Measure object distance in centimeters

```
Distance := Millimeters(Pin) / 10 ' Distance In Centimeters
```

PUB Millimeters(Pin) : Distance

''Measure object distance in millimeters

```
Distance := Ticks(Pin) * 10_000 / TO_CM ' Distance In Millimeters
```



The ping.spin object is used in an example project with the Parallax 4 x 20 Serial LCD (#27979) to display distance measurements. The complete Project Archive can be downloaded from the Propeller Object Exchange at <http://obex.parallax.com>.

Parallax Propeller Chip Project Archive

Project : "ping_demo"

Archived : Tuesday, December 18, 2007 at 3:29:46 PM

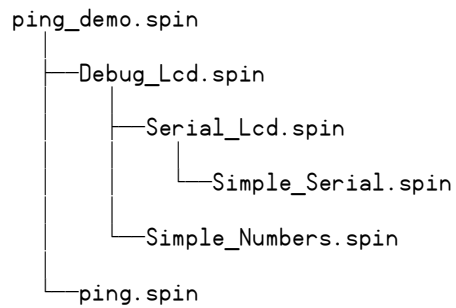
Tool : Propeller Tool version 1.05.8



Javelin Stamp Microcontroller

This class file implements several methods for using the PING))) sensor with the Javelin Stamp module.

```
package stamp.peripheral.sensor;

import stamp.core.*;

/**
 * This class provides an interface to the Parallax PING))) ultrasonic
 * range finder module.
 * <p>
 * <i>Usage:</i><br>
 * <code>
 *   Ping range = new Ping(CPU.pin0);           // trigger and echo on P0
 * </code>
 * <p>
 * Detailed documentation for the PING))) Sensor can be found at: <br>
 * http://www.parallax.com/detail.asp?product\_id=28015
 * <p>
 *
 * @version 1.0 03 FEB 2005
 */
public final class Ping {

    private int ioPin;

    /**
     * Creates PING))) range finder object
     *
     * @param ioPin PING))) trigger and echo return pin
     */
    public Ping (int ioPin) {
        this.ioPin = ioPin;
    }

    /**
     * Returns raw distance value from the PING))) sensor.
     *
     * @return Raw distance value from PING)))
     */
    public int getRaw() {

        int echoRaw = 0;

        CPU.writePin(ioPin, false);           // setup for high-going pulse
        CPU.pulseOut(1, ioPin);               // send trigger pulse
        echoRaw = CPU.pulseIn(2171, ioPin, true); // measure echo return

        // return echo pulse if in range; zero if out-of-range
        return (echoRaw < 2131) ? echoRaw : 0;
    }

    /**
     * The PING))) returns a pulse width of 73.746 uS per inch. Since the
     * Javelin pulseIn() round-trip echo time is in 8.68 uS units, this is the
     * same as a one-way trip in 4.34 uS units. Dividing 73.746 by 4.34 we
     * get a time-per-inch conversion factor of 16.9922 (x 0.058851).
     */
}
```

```

* Values to derive conversion factors are selected to prevent roll-over
* past the 15-bit positive values of Javelin Stamp integers.
*/

/**
 * @return PING))) distance value in inches
 */
public int getIn() {
    return (getRaw() * 3 / 51);           // raw * 0.058824
}

/**
 * @return PING))) distance value in tenths of inches
 */
public int getIn10() {
    return (getRaw() * 3 / 5);           // raw / 1.6667
}

/*
 * The PING))) returns a pulse width of 29.033 uS per centimeter. As the
 * Javelin pulseIn() round-trip echo time is in 8.68 uS units, this is the
 * same as a one-way trip in 4.34 uS units. Dividing 29.033 by 4.34 we
 * get a time-per-centimeter conversion factor of 6.6896.
 *
 * Values to derive conversion factors are selected to prevent roll-over
 * past the 15-bit positive values of Javelin Stamp integers.
 */

/**
 * @return PING))) distance value in centimeters
 */
public int getCm() {
    return (getRaw() * 3 / 20);           // raw / 6.6667
}

/**
 * @return PING))) distance value in millimeters
 */
public int getMm() {
    return (getRaw() * 3 / 2);           // raw / 0.6667
}
}

```

This simple demo illustrates the use of the PING))) ultrasonic range finder class with the Javelin Stamp:

```

import stamp.core.*;
import stamp.peripheral.sensor.Ping;

public class testPing {

    public static final char HOME = 0x01;

    public static void main() {

        Ping range = new Ping(CPU.pin0);
        StringBuffer msg = new StringBuffer();

        int distance;

```

```
while (true) {
  // measure distance to target in inches
  distance = range.getIn();

  // create and display measurement message
  msg.clear();
  msg.append(HOME);
  msg.append(distance);
  msg.append(" \"  \"  \n");
  System.out.print(msg.toString());

  // wait 0.5 seconds between readings
  CPU.delay(5000);
}
}
```

Resources and Downloads

You can find additional resources for the PING))) sensor by searching the following product pages at www.parallax.com:

- Smart Sensors and Applications (a Stamps in Class text), #28029
- PING))) Mounting Bracket Kit – a servo-driven mount designed to attach to a Boe-Bot robot, #570-28015
- Extension cable with 3-in header, #805-00011 (10-in.) or #805-00012 (14-in.)

A video of a Boe-Bot robot using the PING))) sensor to scan its surroundings then drive to the closest object can be found under Resources > Video Library > Boe-Bot Robot Video Gallery.